

HSC PAx

## SCX2000

## ■基本寸法図

(単位：mm)

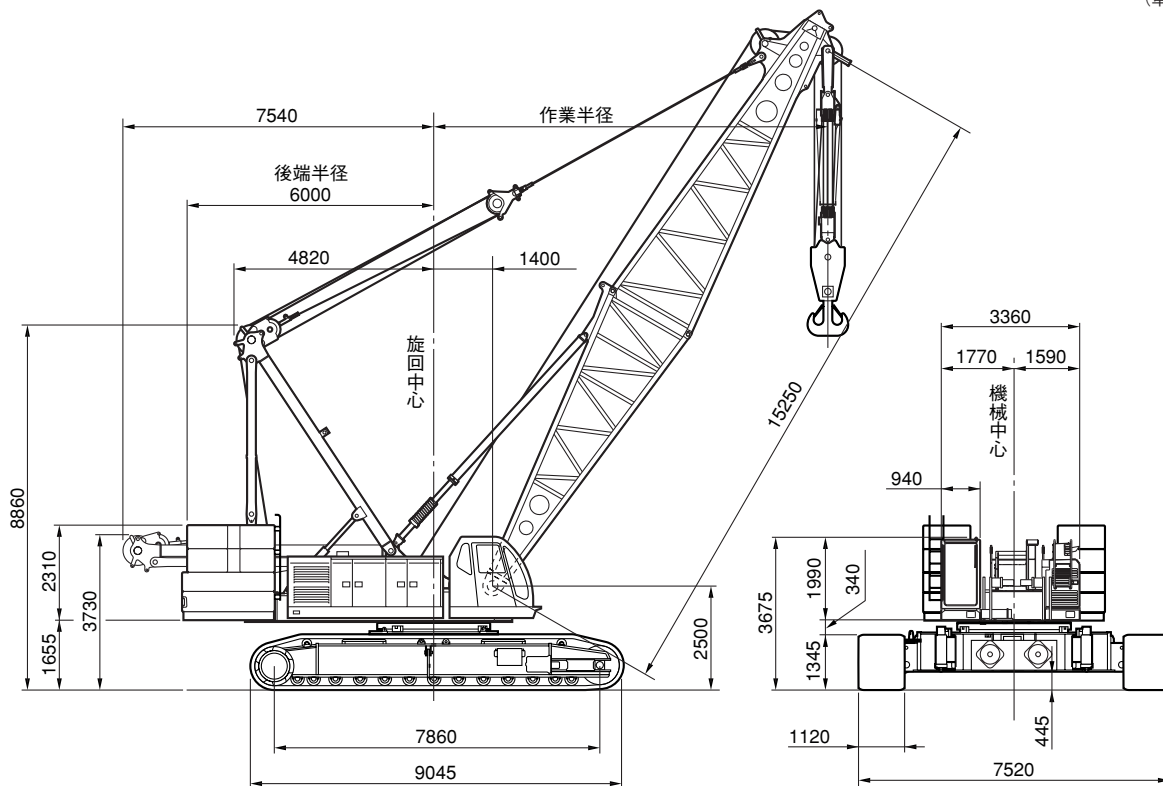

## ■主要仕様

## SCX2000全油圧式クローラークレーン

最大吊上げ能力	200 t×5.0m
基本ブーム長さ	15.25m
最長ブーム長さ	88.40m
補助ジブ長さ	12.20m～36.55m
ブーム+ジブ(最長)	73.15m+36.55m
フロント・リヤドラム巻上/下ロープ速度	120～2.0m/min
ブーム巻上/下ロープ速度	2×(24～1.0) m/min
旋回速度	1.7min <sup>-1</sup>
走行速度	1.2/0.8km/h
エンジン形式	三菱6D24-TL ディーゼルエンジン
定格出力	235kW/2000min <sup>-1</sup>
登坂能力	30% (17°)
平均接地圧 (基本ブーム、1120mmシュー付)	108kPa
作業時質量 (基本ブーム、1120mmシュー付)	約200 t

## ■フロント・リヤドラムロープ掛数と吊上荷重

(単位：t)

フックの種類	定格総荷重の最大値											
	16本掛	14本掛	12本掛	10本掛	8本掛	7本掛	6本掛	5本掛	4本掛	3本掛	2本掛	1本掛
200/125t	200.0	175.0	150.0	125.0	100.0	—	75.0	—	50.0	—	25.0	—
80 t	—	—	—	—	—	80.0	75.0	62.5	50.0	37.5	25.0	13.5
35/25t	—	—	—	—	—	—	—	—	—	—	35.0	25.0
13.5t	—	—	—	—	—	—	—	—	—	—	—	13.5

## ■フック質量

200/125t	3000/2500kg
80t	1400kg
35/25t	900kg
13.5t	600kg

# ブーム支持ロープの構成

## 1 ブーム

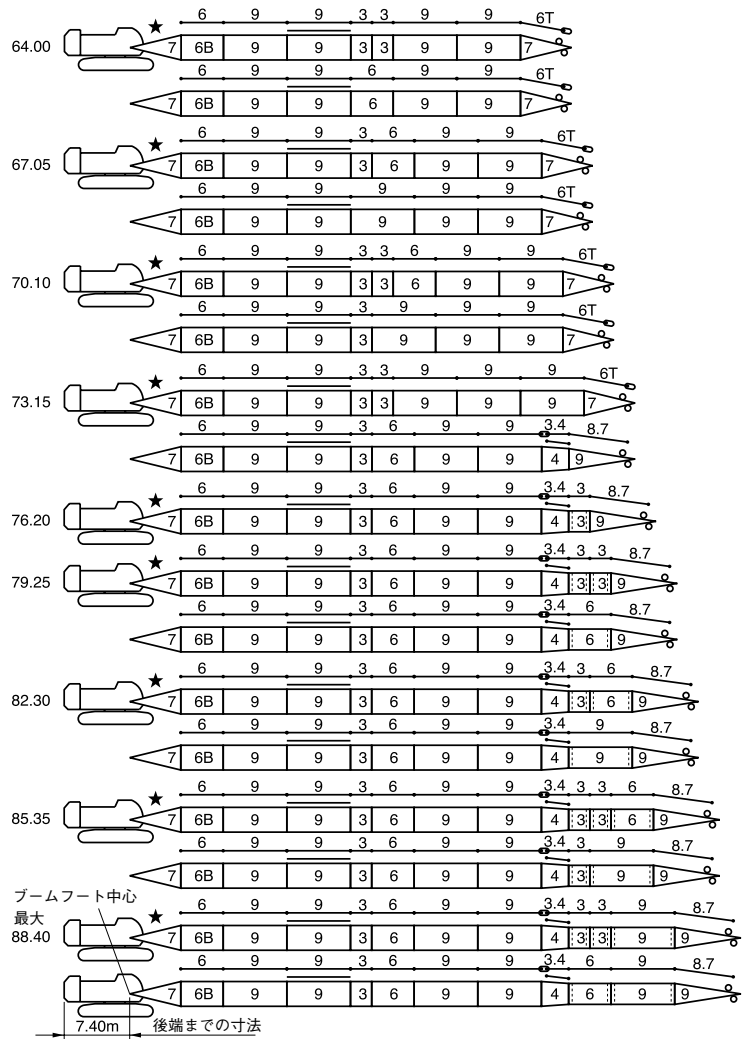
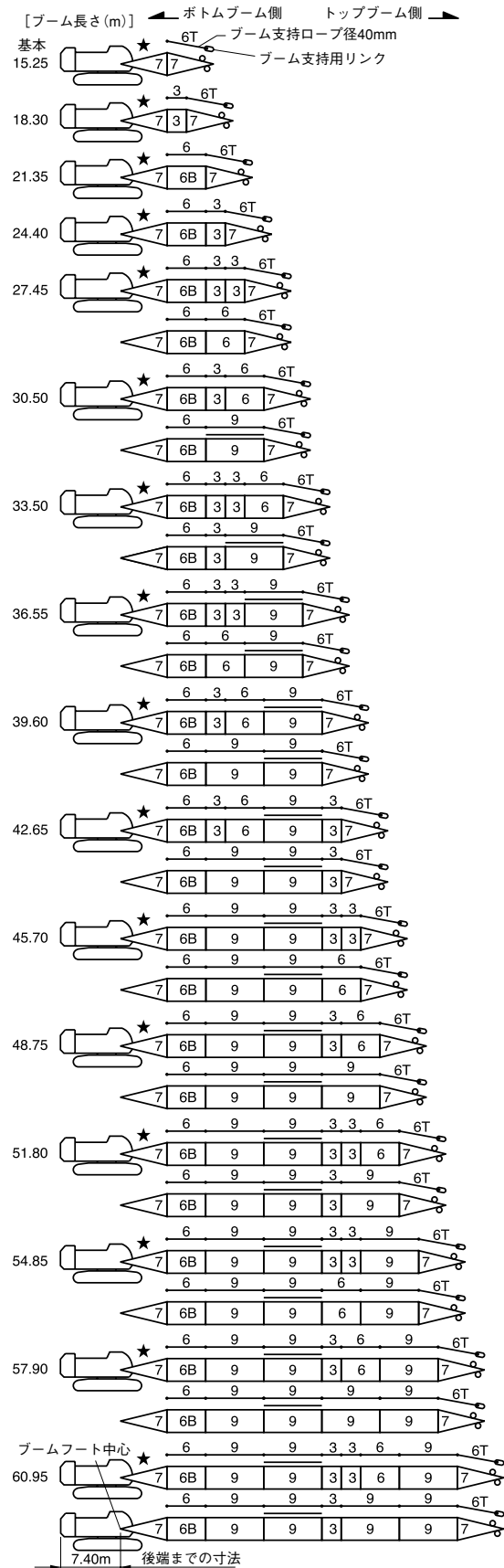

図示省略寸法

略記号	ブーム	ブーム支持ロープ
3	3.05 m	3.05 m
3.4	—	3.40m
4	4.55m	—
6	6.10 m	6.10 m
6B	6.10 m	—
6T	—	6.00 m
7	7.60m	—
8.7	—	8.70m
9	9.15 m	9.15 m

ショートジブ取付  
可能ブーム長さ

ブーム長さ (m)	ショートジブ取付け
15.25	○
18.30	○
21.35	○
24.40	○
27.45	○
30.50	○
33.50	○
36.55	○
39.60	○
42.65	○
45.70	○
48.75	○
51.80	○
54.85	○
57.90	○
60.95	○
64.00	○
67.05	○
70.10	○
73.15	○
76.20	○
79.25	○
82.30	○
85.35	○
88.40	×

(○：可    ×：不可)

- 9 印は、9.15m特殊中間ブームを示します。
- ★印の付いた構成は、そのアタッチメント長さで購入する場合の推奨ブーム構成を示します。

※76m以上ブーム構成にて、ご購入頂く際、70mブーム時には3mEXブームが更に一本必要です。また、73mブーム+補助ジブの構成には上記3mEXブームに加え、更に9mEXブームが一本必要です。仕様決定時、ご注意ください。

# 主ブーム・補助ジブおよび支持ロープの構成

## 補助ジブ

### 1 オフセット角度10°

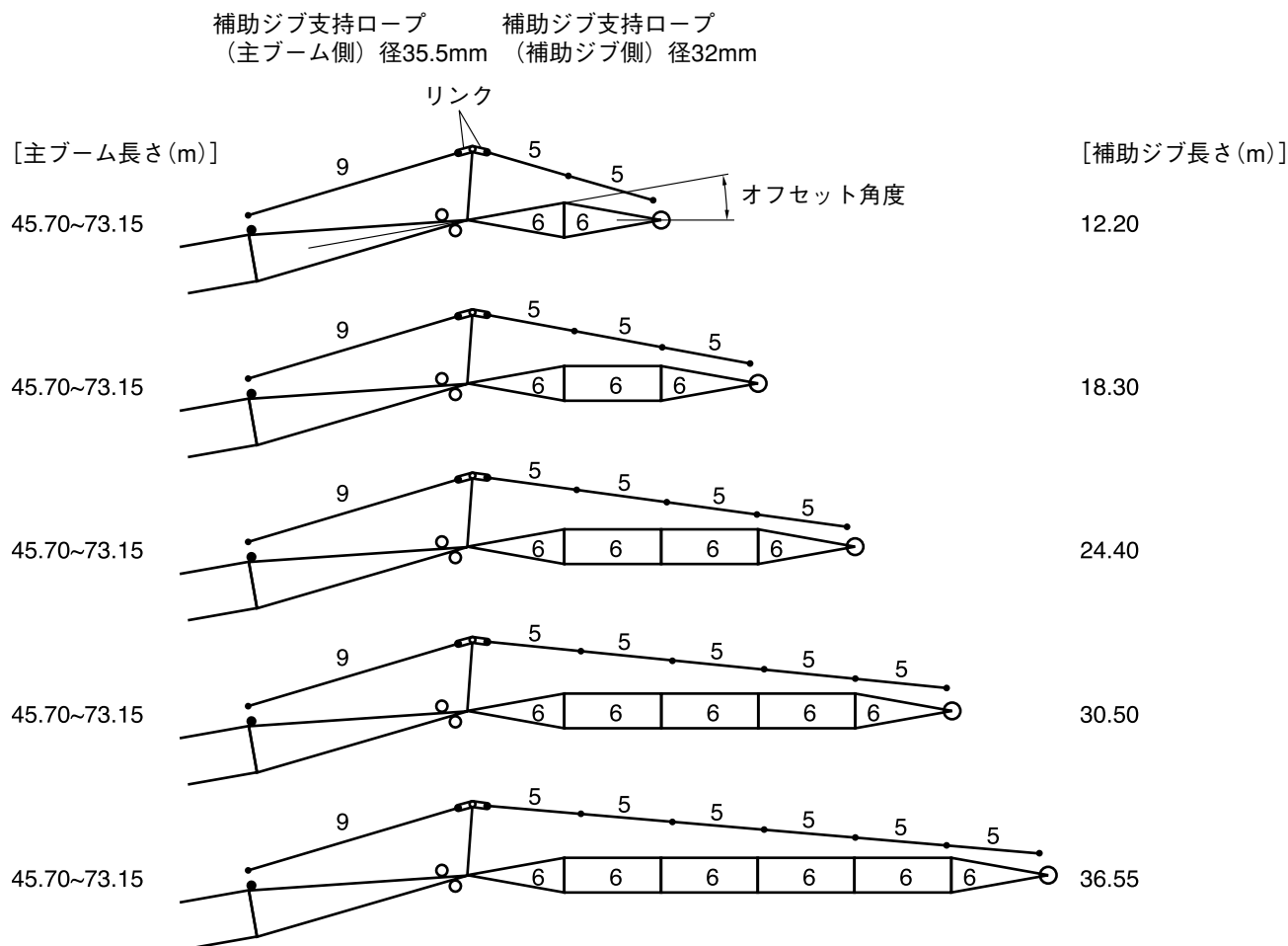

### 2 オフセット角度30°

オフセット角度30°の時は1.30m補助ジブ支持ロープを追加してください。

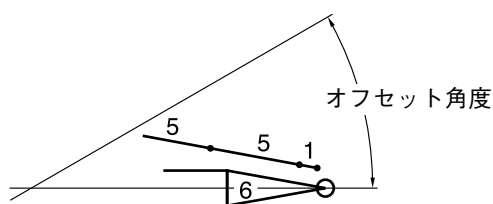

補助ジブ取付け可能主ブーム長さ(ヘビートップクレーン)

主ブーム長さ(m)	補助ジブ長さ(m)				
	オフセット角度10°/30°				
	12.20	18.30	24.40	30.50	36.55
15.25	×	×	×	×	×
18.30	×	×	×	×	×
21.35	×	×	×	×	×
24.40	×	×	×	×	×
27.45	×	×	×	×	×
30.50	×	×	×	×	×
33.50	×	×	×	×	×
36.55	×	×	×	×	×
39.60	×	×	×	×	×
42.65	×	×	×	×	×
45.70	○	○	○	○	○
48.75	○	○	○	○	○
51.80	○	○	○	○	○
54.85	○	○	○	○	○
57.90	○	○	○	○	○
60.95	○	○	○	○	○
64.00	○	○	○	○	○
67.05	○	○	○	○	○
70.10	○	○	○	○	○
73.15	○	○	○	○	○

(○:可 ×:不可)

図示省略寸法

使用箇所 略記号	補助ジブ長さ	補助ジブ支持ロープ (補助ジブ側) ロープ径32mm	補助ジブ支持ロープ (主ブーム側) ロープ径35.5mm
1	—	1.30 m	—
5	—	5.85 m	—
6	6.10 m	—	—
9	—	—	9.15 m

# 作業範囲図

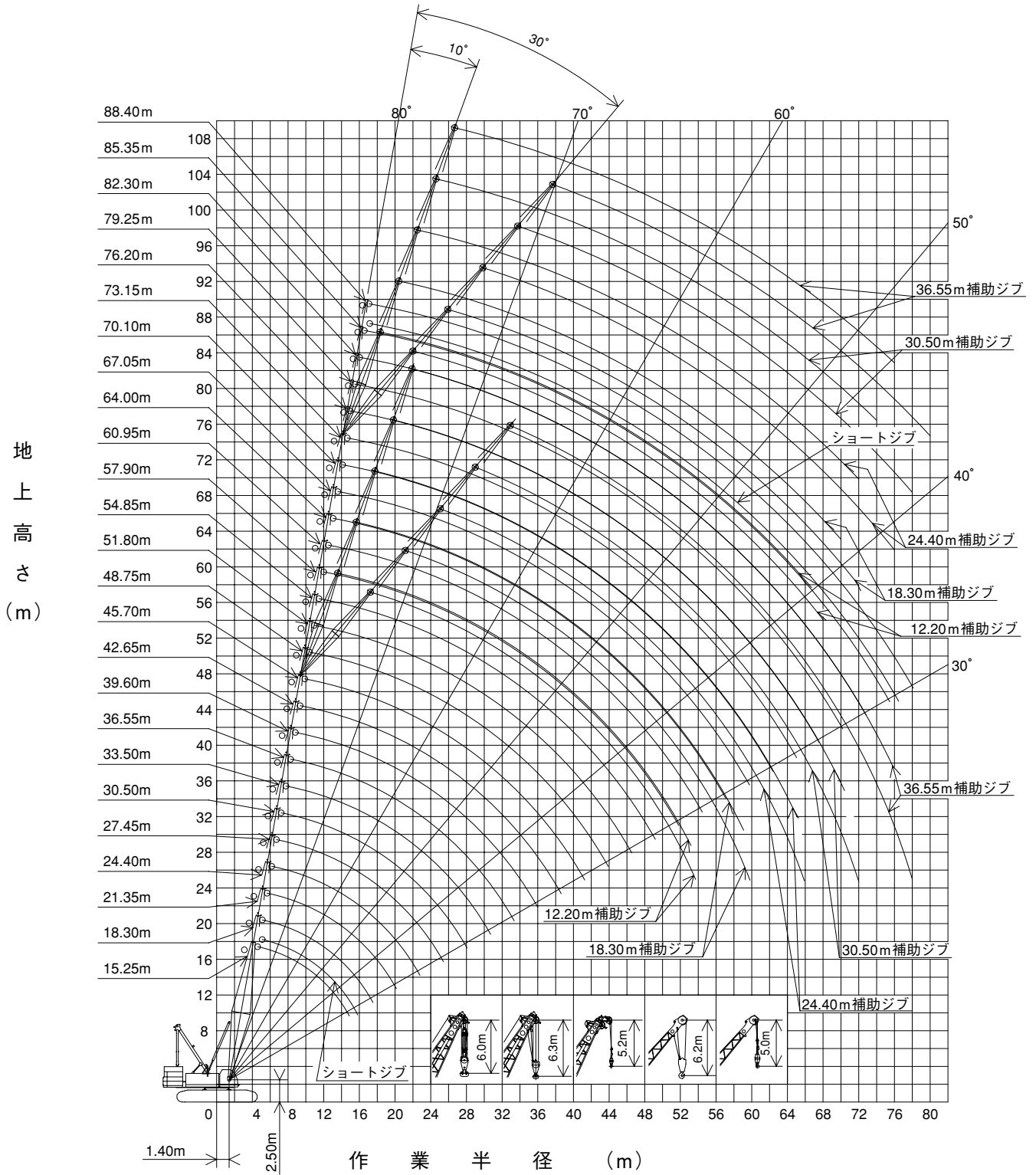



# 定格総荷重表

## ■主ブーム

(単位：t)

作業半径 (m)	主ブーム長さ (m)																			
	15.25	18.30	21.35	24.40	27.45	30.50	33.50	36.55	39.60	42.65	45.70	48.75	51.80	54.85	57.90	60.95	64.00	67.05	70.10	73.15
4.0	200.0/4.6																			
5.0	200.0	192.1/5.2	175.0/5.7																	
6.0	184.7	183.2	175.0	150.0/6.2	150.0/6.8															
7.0	163.5	163.3	162.8	150.0	150.0	125.0/7.3	124.8/7.8													
8.0	143.8	143.6	143.1	142.8	142.5	125.0	124.1	100.0/8.3	100.0/8.9											
9.0	128.2	128.0	127.6	127.3	127.0	125.0	120.4	100.0	100.0	94.9/9.4	80.0/9.9									
10.0	115.6	115.4	115.0	114.7	114.4	114.7	114.4	100.0	100.0	93.5	80.0	75.0/10.5	72.6/11.0	67.0/11.5						
12.0	89.6	89.5	89.3	89.2	89.0	89.5	89.3	89.4	89.2	88.9	80.0	75.0	71.1	66.3	61.9	56.7/12.6	50.0/13.1	48.1/13.6		
14.0	71.9	72.0	71.8	71.7	71.4	71.9	71.7	71.7	71.5	71.2	71.1	71.1	68.4	63.8	59.4	55.3	50.0	47.8	44.3/14.2	37.5/14.7
16.0	63.5/14.8	60.1	59.8	59.6	59.3	59.8	59.5	59.6	59.4	59.1	58.9	58.9	58.6	58.4	57.3	53.4	49.6	46.3	43.0	37.5
18.0		53.3/17.5	51.0	50.8	50.5	51.0	50.7	50.7	50.5	50.2	50.1	50.0	49.7	49.5	49.5	49.2	48.0	44.8	41.6	37.5
20.0			44.4	44.2	43.8	44.3	44.0	44.0	43.8	43.4	43.3	43.2	42.9	42.7	42.7	42.4	42.3	42.2	40.3	36.6
22.0			44.1/20.1	38.9	38.6	39.0	38.7	38.7	38.5	38.1	38.0	37.9	37.6	37.4	37.3	37.0	37.0	36.8	36.5	34.0
24.0				37.3/22.7	34.4	34.7	34.4	34.4	34.2	33.8	33.7	33.6	33.2	33.1	33.0	32.7	32.6	32.4	32.1	31.7
26.0					31.9/25.4	31.3	30.9	30.9	30.6	30.3	30.1	30.0	29.7	29.5	29.4	29.1	29.1	28.9	28.5	28.5
28.0						28.3	28.0	27.9	27.7	27.3	27.2	27.1	26.7	26.5	26.5	26.1	26.1	25.9	25.5	25.5
30.0							25.5	25.4	25.2	24.8	24.6	24.5	24.2	24.0	23.9	23.6	23.5	23.3	23.0	23.0
32.0							24.7/30.7	23.3	23.0	22.6	22.5	22.4	22.0	21.8	21.7	21.4	21.3	21.1	20.8	20.8
34.0								22.0/33.3	21.2	20.8	20.6	20.5	20.1	19.9	19.8	19.5	19.4	19.2	18.9	18.8
36.0									19.6/35.9	19.1	18.9	18.8	18.4	18.3	18.2	17.8	17.7	17.5	17.2	17.2
38.0										17.7	17.5	17.4	17.0	16.8	16.7	16.3	16.3	16.0	15.7	15.7
40.0										17.3/38.6	16.2	16.1	15.7	15.5	15.4	15.0	14.9	14.7	14.4	14.3
42.0											15.5/41.2	14.9	14.5	14.3	14.2	13.8	13.8	13.5	13.2	13.1
44.0												13.9/43.9	13.5	13.3	13.2	12.8	12.7	12.5	12.1	12.1
46.0													12.5	12.3	12.2	11.8	11.7	11.5	11.2	11.1
48.0													12.3/46.5	11.5	11.3	11.0	10.9	10.6	10.3	10.2
50.0														11.1/49.1	10.6	10.2	10.1	9.8	9.5	9.4
52.0															9.9/51.8	9.5	9.3	9.1	8.7	8.7
54.0																8.8	8.7	8.4	8.0	7.9
56.0																8.7/54.4	8.1	7.8	7.3	7.2
58.0																	7.7/57.1	7.1	6.7	6.5
60.0																		6.6/59.7	6.1	5.9
62.0																			5.5	5.3
64.0																			5.4/62.3	4.8
66.0																				4.6/65.0
ロープ掛数	16	16	14	12	12	10	10	8	8	8	7	6	6	6	5	5	4	4	4	3

作業半径 (m)	主ブーム長さ (m)					
	73.15	76.20	79.25	82.30	85.35	88.40
14.0	37.5/14.5	34.5/15.0	32.7/15.5			
16.0	35.9	33.5	32.1	31.5/16.1	25.0/16.5	25.0/17.0
18.0	34.3	31.7	30.4	29.7	25.0	25.0
20.0	32.9	30.2	28.9	28.2	25.0	24.1
22.0	31.6	28.9	27.5	26.9	25.0	23.2
24.0	30.2	27.7	26.3	25.7	24.2	22.1
26.0	28.5	26.2	25.3	24.6	23.1	20.9
28.0	26.0	24.9	24.4	23.5	22.1	20.0
30.0	23.8	23.4	23.1	22.3	21.0	18.9
32.0	21.6	21.7	21.6	20.9	19.9	17.9
34.0	19.8	19.8	19.7	19.7	18.7	16.9
36.0	18.2	18.1	18.1	18.1	17.6	15.9
38.0	16.7	16.6	16.6	16.6	16.3	14.8
40.0	15.3	15.3	15.2	15.2	15.2	13.9
42.0	14.2	14.1	14.1	14.1	14.0	13.1
44.0	13.1	13.0	13.0	13.0	12.9	12.3
46.0	12.1	12.1	12.0	12.0	12.0	11.6
48.0	11.2	11.2	11.1	11.1	11.1	10.9
50.0	10.4	10.4	10.3	10.3	10.3	10.2
52.0	9.7	9.7	9.6	9.6	9.5	9.5
54.0	9.0	9.0	8.9	8.9	8.9	8.9
56.0	8.4	8.4	8.3	8.3	8.3	8.3
58.0	7.8	7.8	7.7	7.7	7.7	7.7
60.0	7.3	7.2	7.1	7.1	7.1	7.1
62.0	6.7	6.6	6.6	6.6	6.6	6.6
64.0	6.2	6.1	6.0	6.0	6.0	6.0
66.0	6.0/64.9	5.6	5.6	5.6	5.6	5.6
68.0		5.3/67.5	5.1	5.1	5.1	5.1
70.0			4.7	4.7	4.7	4.7
72.0			4.6/70.2	4.3	4.3	4.3
74.0				4.1/72.8	3.9	3.9
76.0					3.7/74.8	3.5
78.0						3.2/77.4
ロープ掛数	3	3	3	3	2	2

※ 上段の定格総荷重表はヘビートップブーム(  ) 使用時  
下段の定格総荷重表はライトトップブーム(  ) 使用時を示します。

- 注 1. 定格総荷重は、水平堅土上における値で、転倒荷重の78%以内および移動式クレーン構造規格で定める前方安定度が、1.15以上の両方を満足する値です。  
2. ハッチングで示された定格総荷重は、構造物等の強度により制限される値です。  
3. 実際に吊り上げ得る荷重は、定格総荷重からフック(注)、玉掛けロープ等の吊り具一切の質量を差し引いた値です。  
(注) 主フック作業では「主フック」の質量を、補フック作業では「主フック+補フック」の質量を差し引きます。  
4. 作業を行う場合は、必ずハイガントリにしてください。

# 定格総荷重表

## ■ショートジブ

(単位：t)

作業半径 (m)	主ブーム長さ (m)																			
	15.25	18.30	21.35	24.40	27.45	30.50	33.50	36.55	39.60	42.65	45.70	48.75	51.80	54.85	57.90	60.95	64.00	67.05	70.10	73.15
5.0	13.5/5.5																			
6.0	13.5	13.5	13.5/6.5																	
7.0	13.5	13.5	13.5	13.5/7.1	13.5/7.6															
8.0	13.5	13.5	13.5	13.5	13.5	13.5/8.1	13.5/8.7													
9.0	13.5	13.5	13.5	13.5	13.5	13.5	13.5	13.5/9.2	13.5/9.7											
10.0	13.5	13.5	13.5	13.5	13.5	13.5	13.5	13.5	13.5	13.5/10.2	13.5/10.8	13.5/11.3	13.5/11.8							
12.0	13.5	13.5	13.5	13.5	13.5	13.5	13.5	13.5	13.5	13.5	13.5	13.5	13.5	13.5/12.4	13.5/12.9	13.5/13.4	13.5/13.9			
14.0	13.5	13.5	13.5	13.5	13.5	13.5	13.5	13.5	13.5	13.5	13.5	13.5	13.5	13.5	13.5	13.5	13.5/14.5	13.5/15.0	13.5/15.5	
16.0	13.5	13.5	13.5	13.5	13.5	13.5	13.5	13.5	13.5	13.5	13.5	13.5	13.5	13.5	13.5	13.5	13.5	13.5	13.5	13.5
18.0	13.5/16.1	13.5	13.5	13.5	13.5	13.5	13.5	13.5	13.5	13.5	13.5	13.5	13.5	13.5	13.5	13.5	13.5	13.5	13.5	13.5
20.0		13.5/18.7	13.5	13.5	13.5	13.5	13.5	13.5	13.5	13.5	13.5	13.5	13.5	13.5	13.5	13.5	13.5	13.5	13.5	13.5
22.0			13.5/21.4	13.5	13.5	13.5	13.5	13.5	13.5	13.5	13.5	13.5	13.5	13.5	13.5	13.5	13.5	13.5	13.5	13.5
24.0				13.5	13.5	13.5	13.5	13.5	13.5	13.5	13.5	13.5	13.5	13.5	13.5	13.5	13.5	13.5	13.5	13.5
26.0					13.5	13.5	13.5	13.5	13.5	13.5	13.5	13.5	13.5	13.5	13.5	13.5	13.5	13.5	13.5	13.5
28.0					13.5/26.7	13.5	13.5	13.5	13.5	13.5	13.5	13.5	13.5	13.5	13.5	13.5	13.5	13.5	13.5	13.5
30.0						13.5/29.3	13.5	13.5	13.5	13.5	13.5	13.5	13.5	13.5	13.5	13.5	13.5	13.5	13.5	13.5
32.0							13.5/31.9	13.5	13.5	13.5	13.5	13.5	13.5	13.5	13.5	13.5	13.5	13.5	13.5	13.5
34.0								13.5	13.5	13.5	13.5	13.5	13.5	13.5	13.5	13.5	13.5	13.5	13.5	13.5
36.0								13.5/34.6	13.5	13.5	13.5	13.5	13.5	13.5	13.5	13.5	13.5	13.5	13.5	13.5
38.0									13.5/37.2	13.5	13.5	13.5	13.5	13.5	13.5	13.5	13.5	13.5	13.5	13.5
40.0										13.5/39.9	13.5	13.5	13.5	13.5	13.5	13.5	13.5	13.5	13.5	13.5
42.0											13.5	13.5	13.5	13.5	13.5	13.5	13.5	13.3	12.9	12.9
44.0											13.5/42.5	13.5	13.3	13.1	12.9	12.5	12.4	12.2	11.8	11.8
46.0												13.2/45.1	12.3	12.1	12.0	11.6	11.5	11.2	10.9	10.8
48.0													11.6/47.8	11.2	11.1	10.7	10.6	10.4	10.0	9.9
50.0														10.5	10.3	9.9	9.8	9.6	9.2	9.1
52.0														10.3/50.4	9.6	9.2	9.1	8.8	8.4	8.3
54.0															9.3/53.0	8.5	8.4	8.1	7.6	7.5
56.0																8.0/55.7	7.7	7.4	6.9	6.8
58.0																	7.1	6.8	6.3	6.1
60.0																	7.0/58.3	6.2	5.7	5.5
62.0																		5.9/61.0	5.1	5.0
64.0																			4.7/63.6	4.5
66.0																				4.0
68.0																				3.9/66.2
ロープ掛数	1	1	1	1	1	1	1	1	1	1	1	1	1	1	1	1	1	1	1	1

作業半径 (m)	主ブーム長さ (m)				
	73.15	76.20	79.25	82.30	85.35
14.0	13.5/15.4	13.5/15.9			
16.0	13.5	13.5	13.5/16.5	13.5/17.0	13.5/17.5
18.0	13.5	13.5	13.5	13.5	13.5
20.0	13.5	13.5	13.5	13.5	13.5
22.0	13.5	13.5	13.5	13.5	13.5
24.0	13.5	13.5	13.5	13.5	13.5
26.0	13.5	13.5	13.5	13.5	13.5
28.0	13.5	13.5	13.5	13.5	13.5
30.0	13.5	13.5	13.5	13.5	13.5
32.0	13.5	13.5	13.5	13.5	13.5
34.0	13.5	13.5	13.5	13.5	13.5
36.0	13.5	13.5	13.5	13.5	13.5
38.0	13.5	13.5	13.5	13.5	13.5
40.0	13.5	13.5	13.5	13.5	13.5
42.0	13.5	13.5	13.5	13.5	13.5
44.0	12.8	12.7	12.7	12.7	12.7
46.0	11.8	11.8	11.7	11.7	11.7
48.0	10.9	10.9	10.8	10.8	10.8
50.0	10.1	10.1	10.0	10.0	10.0
52.0	9.4	9.3	9.2	9.2	9.2
54.0	8.7	8.6	8.6	8.6	8.6
56.0	8.1	8.0	7.9	7.9	7.9
58.0	7.5	7.4	7.3	7.3	7.3
60.0	6.9	6.8	6.7	6.7	6.7
62.0	6.3	6.2	6.1	6.1	6.1
64.0	5.8	5.7	5.6	5.6	5.6
66.0	5.3	5.2	5.1	5.1	5.1
68.0	5.3/66.2	4.8	4.7	4.7	4.7
70.0		4.6/68.8	4.2	4.2	4.2
72.0			4.0/71.5	3.8	3.8
74.0				3.5	3.5
76.0				3.5/74.1	3.1
78.0					3.0/76.7
ロープ掛数	1	1	1	1	1

# 定格総荷重表

## ■ ショートジブ付き主ブーム

(単位：t)

作業半径 (m)	主ブーム長さ (m)																			
	15.25	18.30	21.35	24.40	27.45	30.50	33.50	36.55	39.60	42.65	45.70	48.75	51.80	54.85	57.90	60.95	64.00	67.05	70.10	73.15
4.0	200.0/4.6																			
5.0	199.2	191.3/5.2	175.0/5.7																	
6.0	183.9	182.4	175.0	150.0/6.2	150.0/6.8															
7.0	162.6	162.4	162.0	150.0	150.0	125.0/7.3	124.2/7.8													
8.0	143.0	142.7	142.3	142.1	141.8	125.0	123.5	100.0/8.3	100.0/8.9											
9.0	127.4	127.2	126.8	126.6	126.3	125.0	119.8	100.0	100.0	94.2/9.4	80.0/9.9									
10.0	114.8	114.6	114.2	114.0	113.7	113.9	113.6	100.0	100.0	92.8	80.0	75.0/10.5	71.8/11.0	66.1/11.5						
12.0	88.8	88.6	88.5	88.4	88.3	88.6	88.4	88.4	88.2	88.0	80.0	75.0	70.3	65.6	60.9	55.9/12.6	50.0/13.1	47.2/13.6		
14.0	71.0	71.2	71.0	70.9	70.7	71.0	70.7	70.8	70.6	70.3	70.2	70.1	67.6	63.0	58.5	54.5	50.0	46.9	43.3/14.2	37.5/14.7
16.0	62.6/14.8	59.2	59.0	58.9	58.6	58.9	58.6	58.6	58.4	58.1	58.0	57.9	57.6	57.5	56.4	52.6	48.7	45.3	42.0	37.5
18.0		52.5/17.5	50.2	50.1	49.8	50.1	49.8	49.8	49.6	49.2	49.1	49.0	48.7	48.5	48.5	48.2	47.2	43.9	40.8	37.5
20.0			43.6	43.4	43.1	43.4	43.1	43.0	42.8	42.5	42.3	42.3	41.9	41.7	41.7	41.4	41.3	41.1	39.3	35.5
22.0			43.3/20.1	38.2	37.9	38.1	37.8	37.7	37.5	37.2	37.0	36.9	36.6	36.4	36.3	36.0	36.0	35.8	35.4	32.8
24.0				36.6/22.7	33.7	33.9	33.5	33.5	33.3	32.9	32.7	32.6	32.3	32.1	32.0	31.7	31.6	31.4	31.1	30.5
26.0					31.2/25.4	30.4	30.0	30.0	29.7	29.3	29.2	29.1	28.7	28.5	28.5	28.1	28.1	27.8	27.5	27.5
28.0						27.5	27.1	27.0	26.8	26.4	26.2	26.1	25.8	25.6	25.5	25.1	25.1	24.9	24.5	24.5
30.0							24.6	24.5	24.3	23.9	23.7	23.6	23.2	23.0	22.9	22.6	22.5	22.3	21.9	21.9
32.0							23.9/30.7	22.4	22.1	21.7	21.6	21.4	21.1	20.9	20.8	20.4	20.3	20.1	19.8	19.7
34.0								21.2/33.3	20.3	19.9	19.7	19.6	19.2	19.0	18.9	18.5	18.4	18.2	17.8	17.8
36.0									18.8/35.9	18.3	18.0	17.9	17.5	17.3	17.2	16.8	16.8	16.5	16.2	16.1
38.0										16.8	16.6	16.5	16.1	15.8	15.7	15.4	15.3	15.1	14.7	14.6
40.0										16.4/38.6	15.3	15.2	14.8	14.6	14.4	14.0	14.0	13.7	13.4	13.3
42.0											14.6/41.2	14.0	13.6	13.4	13.3	12.9	12.8	12.6	12.2	12.1
44.0												13.1/43.9	12.6	12.4	12.2	11.8	11.7	11.5	11.1	11.1
46.0													11.7	11.4	11.3	10.9	10.8	10.5	10.2	10.1
48.0													11.4/46.5	10.6	10.4	10.0	9.9	9.7	9.3	9.2
50.0														10.2/49.1	9.6	9.2	9.1	8.9	8.4	8.3
52.0															9.0/51.8	8.5	8.4	8.1	7.6	7.5
54.0																7.8	7.7	7.3	6.9	6.7
56.0																7.7/54.4	7.0	6.7	6.2	6.0
58.0																	6.6/57.1	6.0	5.5	5.4
60.0																		5.5/59.7	4.9	4.8
62.0																			4.4	4.2
64.0																			4.3/62.3	3.7
66.0																				3.5/65.0
ロープ掛数	16	16	14	12	12	10	10	8	8	8	7	6	6	6	5	5	4	4	4	3

作業半径 (m)	主ブーム長さ (m)				
	73.15	76.20	79.25	82.30	85.35
14.0	37.5/14.5	34.5/15.0	32.7/15.5		
16.0	35.9	33.5	32.1	31.5/16.1	25.0/16.5
18.0	34.3	31.7	30.4	28.6	25.0
20.0	32.9	29.6	28.3	27.0	25.0
22.0	30.5	27.8	26.4	25.8	25.0
24.0	29.2	26.7	25.3	24.5	23.0
26.0	27.5	25.2	24.3	23.5	22.0
28.0	25.0	23.9	23.1	22.4	21.0
30.0	22.8	22.4	21.9	21.3	19.9
32.0	20.6	20.6	20.5	19.9	18.8
34.0	18.8	18.7	18.7	18.7	17.6
36.0	17.1	17.1	17.0	17.0	16.5
38.0	15.6	15.6	15.5	15.5	15.2
40.0	14.3	14.3	14.2	14.2	14.1
42.0	13.1	13.1	13.0	13.0	13.0
44.0	12.1	12.0	11.9	11.9	11.9
46.0	11.1	11.1	11.0	11.0	11.0
48.0	10.2	10.2	10.1	10.1	10.1
50.0	9.4	9.4	9.3	9.3	9.3
52.0	8.7	8.6	8.6	8.6	8.6
54.0	8.0	8.0	7.9	7.9	7.9
56.0	7.4	7.3	7.2	7.2	7.2
58.0	6.7	6.6	6.6	6.6	6.6
60.0	6.1	6.0	6.0	6.0	6.0
62.0	5.6	5.5	5.4	5.4	5.4
64.0	5.1	5.0	4.9	4.9	4.9
66.0	4.9/64.9	4.5	4.4	4.4	4.4
68.0		4.2/67.5	4.0	3.9	3.9
70.0			3.5	3.5	3.5
72.0			3.5/70.2	3.1	3.1
74.0				3.0/72.8	2.7
76.0					2.6/74.8
ロープ掛数	3	3	3	3	2











# 定格総荷重表

## ■補助ジブ

(単位: t)

主ブーム長さ (m) 補助ジブ長さ (m)	70.10													
	12.20				18.30				24.40		30.50		36.55	
	オフセット角度 (°)													
作業半径 (m)	10		30		10		30	10		30	10		30	
	2本掛	1本掛	2本掛	1本掛	2本掛	1本掛	1本掛	1本掛	1本掛	1本掛	1本掛	1本掛	1本掛	
18.0	22.6/18.5	13.5/18.7												
20.0	21.9	13.5	14.9/21.4	13.5/21.9	18.0/21.1	13.5/21.3								
22.0	21.2	13.5	14.7	13.5	17.6	13.5			12.9/23.4					
24.0	20.4	13.5	14.2	13.5	17.1	13.5	10.6/25.9	12.8			7.0/25.0			
26.0	19.7	13.5	13.7	13.5	16.5	13.5	10.5	12.6			6.9		4.9/26.1	
28.0	18.9	13.5	13.2	13.2	15.9	13.5	10.4	12.5	8.6/29.4	6.8			4.8	
30.0	18.2	13.5	12.7	12.7	15.4	13.5	10.2	12.3	8.5	6.7			4.7	
32.0	17.4	13.5	12.2	12.2	14.8	13.5	10.1	12.2	8.4	6.6	5.4/32.4		4.7	
34.0	16.7	13.5	11.7	11.7	14.2	13.5	9.9	12.0	8.3	6.5	5.3	4.6	3.1/35.0	
36.0	15.9	13.5	11.2	11.2	13.7	13.5	9.8	11.8	8.2	6.5	5.3	4.6	3.0	
38.0	15.1	13.5	10.7	10.7	13.1	13.1	9.6	11.7	8.1	6.4	5.2	4.5	3.0	
40.0	13.8	13.5	10.2	10.2	12.5	12.5	9.5	11.5	7.9	6.3	5.2	4.4	3.0	
42.0	12.6	12.6	9.7	9.7	11.9	11.9	9.3	11.4	7.8	6.2	5.1	4.4	3.0	
44.0	11.5	11.5	9.3	9.3	11.4	11.4	9.2	11.2	7.7	6.1	5.1	4.3	3.0	
46.0	10.5	10.5	8.8	8.8	10.8	10.8	9.0	11.0	7.6	6.0	5.0	4.3	3.0	
48.0	9.7	9.7	8.3	8.3	10.1	10.1	8.9	10.8	7.5	5.9	5.0	4.2	2.9	
50.0	8.9	8.9	7.8	7.8	9.3	9.3	8.7	10.0	7.4	5.8	4.9	4.1	2.9	
52.0	8.1	8.1	7.3	7.3	8.6	8.6	8.6	9.2	7.3	5.7	4.9	4.1	2.9	
54.0	7.3	7.3	6.8	6.8	7.8	7.8	8.4	8.5	7.1	5.6	4.9	4.0	2.9	
56.0	6.5	6.5	6.3	6.3	7.1	7.1	8.0	7.9	7.0	5.6	4.8	4.0	2.9	
58.0	5.9	5.9	5.8	5.8	6.4	6.4	7.3	7.2	6.9	5.5	4.8	3.9	2.9	
60.0	5.2	5.2	5.3	5.3	5.8	5.8	6.6	6.5	6.8	5.4	4.7	3.8	2.9	
62.0	4.7	4.7	4.8	4.8	5.2	5.2	6.0	5.9	6.6	5.3	4.7	3.8	2.8	
64.0	4.1	4.1	4.3	4.3	4.6	4.6	5.3	5.4	6.0	5.2	4.6	3.7	2.8	
66.0	3.6	3.6	3.8	3.8	4.1	4.1	4.8	4.8	5.4	5.1	4.6	3.7	2.8	
68.0	3.1	3.1	3.3	3.3	3.6	3.6	4.2	4.3	4.8	4.6	4.5	3.6	2.8	
70.0		2.9/68.7		3.1/68.8	3.2	3.2	3.7	3.8	4.3	4.1	4.5	3.5	2.8	
72.0						3.0/70.7	3.3	3.4	3.8	3.7	4.3	3.5	2.8	
74.0							2.8	3.0	3.4	3.3	3.8	3.4	2.7	
76.0									2.9	2.9	3.4	3.0	2.7	
78.0											3.0	2.7	2.7	
80.0											2.6		2.7	
82.0													2.6	

主ブーム長さ (m) 補助ジブ長さ (m)	73.15													
	12.20				18.30				24.40		30.50		36.55	
	オフセット角度 (°)													
作業半径 (m)	10		30		10		30	10		30	10		30	
	2本掛	1本掛	2本掛	1本掛	2本掛	1本掛	1本掛	1本掛	1本掛	1本掛	1本掛	1本掛	1本掛	
18.0	19.6/19.0	13.5/19.3												
20.0	19.2	13.5			17.7/21.6	13.5/21.9								
22.0	18.5	13.5	14.8	13.5/22.4	17.5	13.5								
24.0	17.9	13.5	14.3	13.5	16.9	13.5			12.9		7.0/25.5			
26.0	17.2	13.5	13.8	13.5	16.4	13.5	10.6/26.4	12.5			6.9		4.9/26.6	
28.0	16.6	13.5	13.3	13.3	15.8	13.5	10.4	12.1	8.6/29.9	6.8			4.8	
30.0	15.9	13.5	12.8	12.8	15.2	13.5	10.3	11.7	8.5	6.8			4.8	
32.0	15.3	13.5	12.3	12.3	14.7	13.5	10.1	11.3	8.4	6.7	5.4/32.9		4.7	
34.0	14.7	13.5	11.8	11.8	14.1	13.5	10.0	10.9	8.3	6.6	5.3	4.6	3.1/35.5	
36.0	14.0	13.5	11.3	11.3	13.5	13.5	9.8	10.5	8.2	6.5	5.3	4.6	3.0	
38.0	13.4	13.4	10.8	10.8	13.0	13.0	9.7	10.1	8.1	6.4	5.2	4.5	3.0	
40.0	12.7	12.7	10.3	10.3	12.4	12.4	9.6	9.7	8.0	6.3	5.2	4.5	3.0	
42.0	12.1	12.1	9.8	9.8	11.9	11.9	9.4	9.3	7.9	6.2	5.1	4.4	3.0	
44.0	11.3	11.3	9.3	9.3	11.3	11.3	9.3	8.9	7.8	6.1	5.1	4.4	3.0	
46.0	10.3	10.3	8.8	8.8	10.7	10.7	9.1	8.6	7.7	6.1	5.1	4.3	3.0	
48.0	9.5	9.5	8.3	8.3	9.9	9.9	9.0	8.2	7.6	6.0	5.0	4.2	3.0	
50.0	8.6	8.6	7.8	7.8	9.1	9.1	8.8	7.8	7.4	5.9	5.0	4.2	2.9	
52.0	7.8	7.8	7.3	7.3	8.4	8.4	8.7	7.4	7.3	5.8	4.9	4.1	2.9	
54.0	7.0	7.0	6.8	6.8	7.6	7.6	8.5	7.0	7.2	5.7	4.9	4.1	2.9	
56.0	6.3	6.3	6.3	6.3	6.8	6.8	7.8	6.6	7.1	5.6	4.8	4.0	2.9	
58.0	5.6	5.6	5.8	5.8	6.1	6.1	7.0	6.2	7.0	5.5	4.8	3.9	2.9	
60.0	5.0	5.0	5.2	5.2	5.5	5.5	6.4	5.8	6.9	5.4	4.7	3.9	2.9	
62.0	4.4	4.4	4.6	4.6	4.9	4.9	5.7	5.4	6.3	5.4	4.7	3.8	2.9	
64.0	3.8	3.8	4.1	4.1	4.3	4.3	5.1	5.0	5.7	5.3	4.7	3.8	2.8	
66.0	3.3	3.3	3.5	3.5	3.8	3.8	4.5	4.6	5.1	4.8	4.6	3.7	2.8	
68.0		3.1/66.6	3.0	3.0	3.3	3.3	4.0	4.0	4.6	4.3	4.6	3.7	2.8	
70.0			2.9/68.8	2.9	2.9	2.9	3.5	3.6	4.1	3.9	4.5	3.6	2.8	
72.0						2.8/70.7	3.0	3.1	3.6	3.4	4.1	3.5	2.8	
74.0									3.1	3.0	3.6	3.2	2.8	
76.0									2.7		3.2	2.8	2.7	
78.0											2.8		2.7	
80.0													2.7	

# 定格総荷重表

## ■補助ジブ付き主ブーム

(単位：t)

主ブーム長さ(m) 補助ジブ長さ(m)	45.70									
	12.20		18.30		24.40		30.50		36.55	
	オフセット角度(°)		オフセット角度(°)		オフセット角度(°)		オフセット角度(°)		オフセット角度(°)	
作業半径(m)	10	30	10	30	10	30	10	30	10	30
9.0	75.0/9.9	75.0/9.9	75.0/9.9	75.0/9.9	75.0/9.9	75.0/9.9	75.0/9.9	73.2/9.9	72.4/9.9	71.9/9.9
10.0	75.0	75.0	75.0	75.0	75.0	75.0	75.0	72.9	72.1	71.5
12.0	74.7	74.5	73.8	73.7	72.7	72.3	71.7	71.4	70.6	70.0
14.0	65.1	64.7	64.2	64.2	64.0	63.1	63.2	62.0	62.4	60.8
16.0	53.4	53.0	52.5	52.7	52.4	51.7	51.6	50.6	50.8	49.5
18.0	44.9	44.6	44.0	44.2	43.9	43.3	43.1	42.3	42.3	41.3
20.0	38.4	38.1	37.6	37.8	37.4	36.9	36.7	36.0	35.9	35.0
22.0	33.2	33.0	32.5	32.8	32.3	31.9	31.6	31.0	30.8	30.1
24.0	29.1	28.9	28.4	28.7	28.2	27.9	27.5	27.0	26.8	26.1
26.0	25.7	25.6	25.0	25.3	24.9	24.6	24.1	23.7	23.4	22.9
28.0	22.9	22.8	22.2	22.5	22.0	21.8	21.3	21.0	20.6	20.1
30.0	20.5	20.4	19.8	20.1	19.6	19.4	18.9	18.6	18.2	17.8
32.0	18.4	18.3	17.7	18.1	17.6	17.4	16.9	16.6	16.2	15.8
34.0	16.6	16.5	15.9	16.3	15.8	15.6	15.1	14.9	14.4	14.1
36.0	15.0	15.0	14.4	14.8	14.2	14.1	13.6	13.4	12.9	12.6
38.0	13.7	13.6	13.0	13.4	12.9	12.8	12.2	12.1	11.5	11.3
40.0	12.5	12.4	11.8	12.2	11.7	11.6	11.0	10.9	10.3	10.2
42.0	11.8/41.2	11.8/41.2	11.2/41.2	11.6/41.2	11.0/41.2	10.9/41.2	10.3/41.2	10.3/41.2	9.7/41.2	9.6/41.2

主ブーム長さ(m) 補助ジブ長さ(m)	48.75									
	12.20		18.30		24.40		30.50		36.55	
	オフセット角度(°)		オフセット角度(°)		オフセット角度(°)		オフセット角度(°)		オフセット角度(°)	
作業半径(m)	10	30	10	30	10	30	10	30	10	30
10.0	62.5/10.5	62.5/10.5	62.5/10.5	62.5/10.5	62.5/10.5	62.5/10.5	62.5/10.5	62.5/10.5	62.5/10.5	62.5/10.5
12.0	62.5	62.5	62.5	62.5	62.5	62.5	62.5	62.5	62.1	61.5
14.0	62.5	62.5	62.5	62.5	62.5	62.3	61.7	61.4	60.6	60.0
16.0	53.3	53.0	52.5	52.6	52.3	51.6	51.5	50.6	50.8	49.5
18.0	44.8	44.5	44.0	44.2	43.8	43.2	43.1	42.3	42.3	41.3
20.0	38.3	38.0	37.5	37.7	37.4	36.9	36.6	35.9	35.9	35.0
22.0	33.2	32.9	32.4	32.7	32.3	31.8	31.5	31.0	30.8	30.1
24.0	29.0	28.8	28.3	28.6	28.2	27.8	27.4	27.0	26.7	26.1
26.0	25.6	25.4	24.9	25.2	24.8	24.5	24.1	23.6	23.4	22.8
28.0	22.8	22.6	22.1	22.4	21.9	21.7	21.3	20.9	20.5	20.1
30.0	20.3	20.2	19.7	20.0	19.5	19.3	18.9	18.5	18.2	17.7
32.0	18.3	18.2	17.6	18.0	17.5	17.3	16.8	16.5	16.1	15.7
34.0	16.5	16.4	15.8	16.2	15.7	15.5	15.0	14.8	14.3	14.0
36.0	14.9	14.8	14.2	14.6	14.1	14.0	13.4	13.3	12.8	12.5
38.0	13.5	13.4	12.9	13.2	12.7	12.6	12.1	11.9	11.4	11.2
40.0	12.3	12.2	11.6	12.0	11.5	11.4	10.9	10.7	10.2	10.0
42.0	11.2	11.1	10.6	11.0	10.4	10.3	9.8	9.7	9.1	9.0
44.0	10.3/43.9	10.2/43.9	9.7/43.9	10.0/43.9	9.5/43.9	9.4/43.9	8.9/43.9	8.8/43.9	8.2/43.9	8.0/43.9

主ブーム長さ(m) 補助ジブ長さ(m)	51.80									
	12.20		18.30		24.40		30.50		36.55	
	オフセット角度(°)		オフセット角度(°)		オフセット角度(°)		オフセット角度(°)		オフセット角度(°)	
作業半径(m)	10	30	10	30	10	30	10	30	10	30
10.0	60.9/11.0	60.7/11.0	60.0/11.0	59.9/11.0	58.9/11.0	58.5/11.0	57.9/11.0	57.6/11.0	56.8/11.0	56.2/11.0
12.0	60.2	60.0	59.3	59.2	58.2	57.8	57.2	56.9	56.1	55.5
14.0	58.7	58.5	57.8	57.7	56.7	56.3	55.7	55.4	54.6	54.0
16.0	53.0	52.7	52.2	52.3	52.1	51.4	51.3	50.3	50.6	49.3
18.0	44.5	44.2	43.7	43.9	43.6	43.0	42.8	42.0	42.1	41.0
20.0	38.0	37.7	37.2	37.4	37.1	36.6	36.4	35.7	35.6	34.7
22.0	32.8	32.6	32.1	32.4	32.0	31.5	31.3	30.7	30.6	29.8
24.0	28.7	28.5	28.0	28.3	27.9	27.5	27.2	26.6	26.5	25.8
26.0	25.3	25.1	24.6	24.9	24.5	24.1	23.8	23.3	23.1	22.5
28.0	22.4	22.3	21.7	22.1	21.6	21.3	21.0	20.6	20.3	19.7
30.0	20.0	19.9	19.3	19.7	19.2	19.0	18.6	18.2	17.9	17.4
32.0	17.9	17.8	17.3	17.6	17.1	16.9	16.5	16.2	15.8	15.4
34.0	16.1	16.0	15.5	15.8	15.3	15.2	14.7	14.4	14.0	13.7
36.0	14.5	14.4	13.9	14.3	13.8	13.6	13.1	12.9	12.5	12.2
38.0	13.1	13.1	12.5	12.9	12.4	12.2	11.7	11.6	11.1	10.8
40.0	11.9	11.8	11.3	11.7	11.1	11.0	10.5	10.4	9.9	9.7
42.0	10.8	10.7	10.2	10.6	10.1	10.0	9.4	9.3	8.8	8.6
44.0	9.8	9.8	9.2	9.6	9.1	9.0	8.5	8.4	7.7	7.5
46.0	8.9	8.9	8.3	8.7	8.2	8.1	7.5	7.4	6.6	6.5
48.0	8.7/46.5	8.7/46.5	8.1/46.5	8.5/46.5	8.0/46.5	7.9/46.5	7.2/46.5	7.2/46.5	6.4/46.5	6.3/46.5

# 定格総荷重表

## ■補助ジブ付き主ブーム

(単位: t)

主ブーム長さ (m) 補助ジブ長さ (m)	54.85									
	12.20		18.30		24.40		30.50		36.55	
	オフセット角度 (°)		オフセット角度 (°)		オフセット角度 (°)		オフセット角度 (°)		オフセット角度 (°)	
作業半径 (m)	10	30	10	30	10	30	10	30	10	30
10.0	50.0/11.5	50.0/11.5	50.0/11.5	50.0/11.5	50.0/11.5	50.0/11.5	50.0/11.5	50.0/11.5	50.0/11.5	50.0/11.5
12.0	50.0	50.0	50.0	50.0	50.0	50.0	50.0	50.0	50.0	50.0
14.0	50.0	50.0	50.0	50.0	50.0	50.0	50.0	49.9	49.1	48.5
16.0	50.0	50.0	50.0	50.0	49.7	49.3	48.7	48.4	47.6	47.0
18.0	44.4	44.1	43.6	43.8	43.5	42.9	42.8	42.0	42.1	41.0
20.0	37.9	37.6	37.1	37.4	37.0	36.5	36.3	35.6	35.6	34.7
22.0	32.8	32.5	32.0	32.3	31.9	31.5	31.2	30.6	30.6	29.7
24.0	28.6	28.4	27.9	28.2	27.8	27.4	27.1	26.6	26.4	25.7
26.0	25.2	25.0	24.5	24.8	24.4	24.1	23.7	23.3	23.1	22.4
28.0	22.3	22.2	21.7	22.0	21.6	21.3	20.9	20.5	20.2	19.7
30.0	19.9	19.8	19.2	19.6	19.1	18.9	18.5	18.1	17.8	17.4
32.0	17.8	17.7	17.2	17.5	17.1	16.8	16.4	16.1	15.8	15.3
34.0	16.0	15.9	15.4	15.7	15.3	15.1	14.6	14.3	14.0	13.6
36.0	14.4	14.3	13.8	14.2	13.7	13.5	13.0	12.8	12.4	12.1
38.0	13.0	12.9	12.4	12.8	12.3	12.1	11.7	11.4	11.0	10.7
40.0	11.8	11.7	11.1	11.5	11.0	10.9	10.4	10.2	9.8	9.5
42.0	10.6	10.6	10.0	10.4	9.9	9.8	9.3	9.2	8.7	8.4
44.0	9.6	9.6	9.1	9.4	8.9	8.8	8.3	8.2	7.5	7.3
46.0	8.8	8.7	8.2	8.6	8.0	8.0	7.3	7.2	6.5	6.3
48.0	7.9	7.9	7.3	7.8	7.1	7.0	6.3	6.3	5.5	5.4
50.0	7.5/49.1	7.5/49.1	6.9/49.1	7.3/49.1	6.6/49.1	6.6/49.1	5.9/49.1	5.8/49.1	5.1/49.1	5.0/49.1

主ブーム長さ (m) 補助ジブ長さ (m)	57.90									
	12.20		18.30		24.40		30.50		36.55	
	オフセット角度 (°)		オフセット角度 (°)		オフセット角度 (°)		オフセット角度 (°)		オフセット角度 (°)	
作業半径 (m)	10	30	10	30	10	30	10	30	10	30
12.0	49.7	49.5	48.8	48.7	47.7	47.3	46.7	46.4	45.6	45.0
14.0	48.2	48.0	47.3	47.2	46.2	45.8	45.2	44.9	44.1	43.5
16.0	46.7	46.5	45.8	45.7	44.7	44.3	43.7	43.4	42.6	42.0
18.0	44.2	43.9	43.4	43.6	43.2	42.7	42.2	41.8	41.1	40.5
20.0	37.7	37.4	36.9	37.2	36.9	36.3	36.2	35.4	35.5	34.5
22.0	32.5	32.3	31.8	32.1	31.7	31.3	31.1	30.4	30.4	29.6
24.0	28.4	28.2	27.7	28.0	27.6	27.2	27.0	26.4	26.3	25.6
26.0	25.0	24.8	24.3	24.6	24.2	23.9	23.6	23.1	22.9	22.3
28.0	22.1	21.9	21.4	21.8	21.4	21.1	20.7	20.3	20.1	19.5
30.0	19.7	19.5	19.0	19.4	18.9	18.7	18.3	17.9	17.7	17.2
32.0	17.6	17.5	16.9	17.3	16.9	16.6	16.2	15.9	15.6	15.1
34.0	15.8	15.6	15.1	15.5	15.1	14.8	14.4	14.1	13.8	13.4
36.0	14.2	14.1	13.5	13.9	13.5	13.3	12.8	12.6	12.2	11.9
38.0	12.8	12.7	12.1	12.5	12.1	11.9	11.5	11.2	10.8	10.5
40.0	11.5	11.4	10.9	11.3	10.8	10.7	10.2	10.0	9.6	9.3
42.0	10.4	10.3	9.8	10.2	9.7	9.6	9.1	8.9	8.4	8.1
44.0	9.4	9.3	8.8	9.2	8.7	8.6	8.1	7.9	7.2	7.0
46.0	8.5	8.5	7.9	8.3	7.8	7.7	7.0	6.8	6.2	6.0
48.0	7.7	7.6	7.0	7.5	6.8	6.7	6.1	5.9	5.3	5.1
50.0	6.9	6.8	6.1	6.6	5.9	5.9	5.2	5.1	4.4	4.3
52.0	6.2/51.8	6.1/51.8	5.5/51.8	5.9/51.8	5.2/51.8	5.2/51.8	4.5/51.8	4.4/51.8		

主ブーム長さ (m) 補助ジブ長さ (m)	60.95									
	12.20		18.30		24.40		30.50		36.55	
	オフセット角度 (°)		オフセット角度 (°)		オフセット角度 (°)		オフセット角度 (°)		オフセット角度 (°)	
作業半径 (m)	10	30	10	30	10	30	10	30	10	30
12.0	45.1/12.6	44.9/12.6	44.2/12.6	44.1/12.6	43.1/12.6	42.7/12.6	42.1/12.6	41.8/12.6	41.0/12.6	40.4/12.6
14.0	44.1	43.9	43.2	43.1	42.1	41.7	41.1	40.8	40.0	39.4
16.0	42.6	42.4	41.7	41.6	40.6	40.2	39.6	39.3	38.5	37.9
18.0	41.1	40.9	40.2	40.1	39.1	38.7	38.1	37.8	37.0	36.4
20.0	37.4	37.1	36.6	36.9	36.6	36.0	35.9	35.2	35.2	34.3
22.0	32.2	32.0	31.5	31.8	31.4	31.0	30.8	30.1	30.1	29.3
24.0	28.1	27.8	27.4	27.7	27.3	26.9	26.7	26.1	26.0	25.3
26.0	24.6	24.4	24.0	24.3	23.9	23.5	23.3	22.8	22.6	22.0
28.0	21.8	21.6	21.1	21.4	21.1	20.7	20.4	20.0	19.8	19.2
30.0	19.3	19.2	18.7	19.0	18.6	18.3	18.0	17.6	17.4	16.8
32.0	17.2	17.1	16.6	17.0	16.5	16.3	15.9	15.6	15.3	14.8
34.0	15.4	15.3	14.8	15.2	14.7	14.5	14.1	13.8	13.5	13.1
36.0	13.8	13.7	13.2	13.6	13.1	12.9	12.5	12.3	11.9	11.5
38.0	12.4	12.3	11.8	12.2	11.7	11.6	11.1	10.9	10.5	10.2
40.0	11.2	11.1	10.6	10.9	10.5	10.3	9.9	9.7	9.3	8.9
42.0	10.0	10.0	9.4	9.8	9.4	9.2	8.8	8.5	8.0	7.7
44.0	9.0	9.0	8.4	8.8	8.4	8.2	7.6	7.4	6.8	6.5
46.0	8.1	8.1	7.5	7.9	7.3	7.2	6.5	6.4	5.8	5.5
48.0	7.2	7.2	6.5	7.0	6.3	6.2	5.6	5.4	4.8	4.6
50.0	6.4	6.3	5.6	6.1	5.5	5.4	4.7	4.6	4.0	
52.0	5.6	5.5	4.9	5.3	4.7	4.6	3.9			
54.0	4.8	4.8	4.2	4.6	4.0	3.9				
56.0	4.7/54.4	4.7/54.4	4.0/54.4	4.5/54.4	3.8/54.4	3.8/54.4				

# 定格総荷重表

## ■補助ジブ付き主ブーム

(単位：t)

主ブーム長さ (m) 補助ジブ長さ (m)	64.00									
	12.20		18.30		24.40		30.50		36.55	
	オフセット角度 (°)		オフセット角度 (°)		オフセット角度 (°)		オフセット角度 (°)		オフセット角度 (°)	
作業半径 (m)	10	30	10	30	10	30	10	30	10	30
12.0	40.7/13.1	40.5/13.1	39.8/13.1	39.7/13.1	38.7/13.1	38.3/13.1	37.7/13.1	37.4/13.1	36.6/13.1	36.0/13.1
14.0	40.1	39.9	39.2	39.1	38.1	37.7	37.1	36.8	36.0	35.4
16.0	38.6	38.4	37.7	37.6	36.6	36.2	35.6	35.3	34.5	33.9
18.0	37.1	36.9	36.2	36.1	35.1	34.7	34.1	33.8	33.0	32.4
20.0	35.6	35.4	34.7	34.6	33.6	33.2	32.6	32.3	31.5	30.9
22.0	32.0	31.8	31.3	31.6	31.3	30.8	30.6	30.0	30.0	29.1
24.0	27.9	27.6	27.2	27.5	27.1	26.7	26.5	25.9	25.8	25.1
26.0	24.4	24.2	23.8	24.1	23.7	23.3	23.1	22.6	22.4	21.8
28.0	21.6	21.4	20.9	21.2	20.9	20.5	20.2	19.8	19.6	19.0
30.0	19.1	19.0	18.5	18.8	18.4	18.1	17.8	17.4	17.2	16.7
32.0	17.0	16.9	16.4	16.7	16.3	16.1	15.7	15.4	15.1	14.6
34.0	15.2	15.1	14.6	14.9	14.5	14.3	13.9	13.6	13.3	12.9
36.0	13.6	13.5	13.0	13.4	12.9	12.7	12.3	12.0	11.7	11.3
38.0	12.2	12.1	11.6	12.0	11.5	11.3	10.9	10.7	10.3	10.0
40.0	10.9	10.8	10.3	10.7	10.3	10.1	9.7	9.5	9.0	8.6
42.0	9.8	9.7	9.2	9.6	9.2	9.0	8.5	8.3	7.7	7.4
44.0	8.8	8.7	8.2	8.6	8.1	7.9	7.3	7.1	6.6	6.3
46.0	7.9	7.8	7.2	7.6	7.0	6.9	6.3	6.1	5.5	5.2
48.0	6.9	6.9	6.2	6.7	6.1	5.9	5.3	5.1	4.5	4.3
50.0	6.0	6.0	5.3	5.8	5.2	5.1	4.4	4.3		
52.0	5.2	5.2	4.5	5.0	4.4	4.3				
54.0	4.5	4.5	3.8	4.3						
56.0	3.8	3.8		3.6						

主ブーム長さ (m) 補助ジブ長さ (m)	67.05									
	12.20		18.30		24.40		30.50		36.55	
	オフセット角度 (°)		オフセット角度 (°)		オフセット角度 (°)		オフセット角度 (°)		オフセット角度 (°)	
作業半径 (m)	10	30	10	30	10	30	10	30	10	30
12.0	37.4/13.6	37.2/13.6	36.5/13.6	36.4/13.6	35.4/13.6	35.0/13.6	34.4/13.6	34.1/13.6	33.3/13.6	32.7/13.6
14.0	37.1	36.9	36.2	36.1	35.1	34.7	34.1	33.8	33.0	32.4
16.0	35.6	35.4	34.7	34.6	33.6	33.2	32.6	32.3	31.5	30.9
18.0	34.1	33.9	33.2	33.1	32.1	31.7	31.1	30.8	30.0	29.4
20.0	32.6	32.4	31.7	31.6	30.6	30.2	29.6	29.3	28.5	27.9
22.0	31.1	30.9	30.2	30.1	29.1	28.7	28.1	27.8	27.0	26.4
24.0	27.8	27.6	27.1	27.4	27.1	26.7	26.5	25.9	25.5	24.9
26.0	24.4	24.2	23.7	24.0	23.7	23.3	23.1	22.5	22.4	21.7
28.0	21.5	21.3	20.8	21.2	20.8	20.5	20.2	19.7	19.6	19.0
30.0	19.0	18.9	18.4	18.8	18.4	18.1	17.8	17.4	17.2	16.6
32.0	16.9	16.8	16.3	16.7	16.3	16.0	15.7	15.3	15.1	14.6
34.0	15.1	15.0	14.5	14.9	14.5	14.2	13.9	13.5	13.3	12.8
36.0	13.5	13.4	12.9	13.3	12.9	12.6	12.3	12.0	11.7	11.3
38.0	12.1	12.0	11.5	11.9	11.5	11.3	10.9	10.6	10.3	9.9
40.0	10.8	10.7	10.2	10.6	10.2	10.0	9.6	9.4	8.9	8.5
42.0	9.7	9.6	9.1	9.5	9.1	8.9	8.4	8.1	7.6	7.3
44.0	8.7	8.6	8.1	8.5	7.9	7.8	7.2	7.0	6.4	6.1
46.0	7.7	7.6	7.0	7.5	6.9	6.7	6.1	5.9	5.4	5.1
48.0	6.7	6.7	6.0	6.5	5.9	5.8	5.2	5.0	4.4	4.2
50.0	5.9	5.8	5.1	5.6	5.0	4.9	4.3	4.1		
52.0	5.0	5.0	4.3	4.8	4.2	4.1				
54.0	4.3	4.2		4.1						
56.0	3.6	3.6								

主ブーム長さ (m) 補助ジブ長さ (m)	70.10									
	12.20		18.30		24.40		30.50		36.55	
	オフセット角度 (°)		オフセット角度 (°)		オフセット角度 (°)		オフセット角度 (°)		オフセット角度 (°)	
作業半径 (m)	10	30	10	30	10	30	10	30	10	30
14.0	34.4/14.2	34.2/14.2	33.5/14.2	33.4/14.2	32.4/14.2	32.0/14.2	31.4/14.2	31.1/14.2	30.3/14.2	29.7/14.2
16.0	33.1	32.9	32.2	32.1	31.1	30.7	30.1	29.8	29.0	28.4
18.0	31.6	31.4	30.7	30.6	29.6	29.2	28.6	28.3	27.5	26.9
20.0	30.1	29.9	29.2	29.1	28.1	27.7	27.1	26.8	26.0	25.4
22.0	28.6	28.4	27.7	27.6	26.6	26.2	25.6	25.3	24.5	23.9
24.0	27.1	26.9	26.2	26.1	25.1	24.7	24.1	23.8	23.0	22.4
26.0	24.0	23.8	23.4	23.7	23.4	23.0	22.6	22.2	21.5	20.9
28.0	21.2	21.0	20.5	20.8	20.5	20.1	19.9	19.4	19.3	18.7
30.0	18.7	18.5	18.1	18.4	18.1	17.7	17.5	17.0	16.9	16.3
32.0	16.6	16.4	16.0	16.3	16.0	15.7	15.4	15.0	14.8	14.3
34.0	14.8	14.6	14.1	14.5	14.1	13.9	13.5	13.2	13.0	12.5
36.0	13.2	13.0	12.5	12.9	12.5	12.3	12.0	11.6	11.4	10.9
38.0	11.7	11.6	11.1	11.5	11.1	10.9	10.5	10.3	10.0	9.5
40.0	10.5	10.4	9.9	10.3	9.9	9.7	9.3	9.0	8.5	8.1
42.0	9.3	9.2	8.8	9.2	8.7	8.5	8.0	7.7	7.2	6.8
44.0	8.3	8.2	7.6	8.1	7.5	7.3	6.8	6.5	6.0	5.7
46.0	7.2	7.1	6.5	7.0	6.4	6.2	5.7	5.5	5.0	4.6
48.0	6.3	6.2	5.5	6.0	5.4	5.3	4.7	4.5		
50.0	5.4	5.3	4.7	5.1	4.6	4.4				
52.0	4.6	4.5		4.3						
54.0	3.8									

# 定格総荷重表

## ■補助ジブ付き主ブーム

(単位：t)

主ブーム長さ (m)	73.15											
	12.20		18.30		24.40		30.50		36.55			
	オフセット角度 (°)		オフセット角度 (°)		オフセット角度 (°)		オフセット角度 (°)		オフセット角度 (°)			
補助ジブ長さ (m)	10		30		10		30		10		30	
作業半径 (m)	32.0/14.7	31.8/14.7	31.1/14.7	31.0/14.7	30.0/14.7	29.6/14.7	29.0/14.7	28.7/14.7	27.9/14.7	27.3/14.7		
14.0	32.0/14.7	31.8/14.7	31.1/14.7	31.0/14.7	30.0/14.7	29.6/14.7	29.0/14.7	28.7/14.7	27.9/14.7	27.3/14.7		
16.0	31.1	30.9	30.2	30.1	29.1	28.7	28.1	27.8	27.0	26.4		
18.0	29.6	29.4	28.7	28.6	27.6	27.2	26.6	26.3	25.5	24.9		
20.0	28.1	27.9	27.2	27.1	26.1	25.7	25.1	24.8	24.0	23.4		
22.0	26.6	26.4	25.7	25.6	24.6	24.2	23.6	23.3	22.5	21.9		
24.0	25.1	24.9	24.2	24.1	23.1	22.7	22.1	21.8	21.0	20.4		
26.0	23.6	23.4	22.7	22.6	21.6	21.2	20.6	20.3	19.5	18.9		
28.0	20.9	20.7	20.3	20.6	20.1	19.7	19.1	18.8	18.0	17.4		
30.0	18.5	18.3	17.9	18.2	17.9	17.5	17.3	16.8	16.5	15.9		
32.0	16.4	16.2	15.8	16.1	15.8	15.5	15.2	14.8	14.6	14.1		
34.0	14.5	14.4	13.9	14.3	13.9	13.7	13.4	13.0	12.8	12.3		
36.0	12.9	12.8	12.3	12.7	12.3	12.1	11.8	11.4	11.2	10.7		
38.0	11.5	11.4	10.9	11.3	10.9	10.7	10.3	10.0	9.7	9.2		
40.0	10.2	10.1	9.7	10.1	9.7	9.5	9.0	8.7	8.3	7.8		
42.0	9.1	9.0	8.5	8.9	8.4	8.2	7.7	7.4	6.9	6.5		
44.0	8.0	7.9	7.3	7.8	7.2	7.0	6.5	6.2	5.8	5.4		
46.0	6.9	6.8	6.2	6.7	6.1	6.0	5.4	5.2	4.7	4.4		
48.0	6.0	5.9	5.2	5.7	5.1	5.0	4.5	4.2				
50.0	5.1	5.0	4.4	4.8	4.3	4.1						
52.0	4.2	4.2		4.0								